

SORTIE PUISSANCE < 630A
CABLES OUTLET < 630A

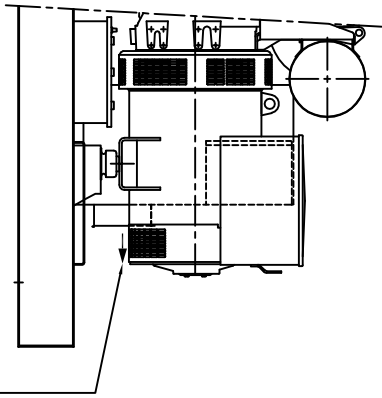

COFFRET COMMANDE/PUISSANCE
CONTROL PANEL/POWER MODULE
SORTIE CABLES
WIRES OUTLET

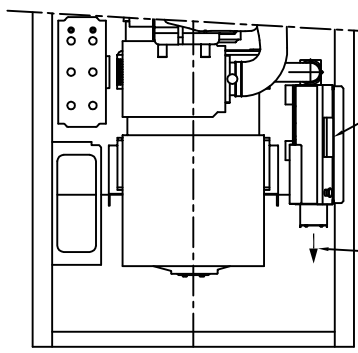

SORTIE ECHAPPEMENT/EXHAUST OUTLET
BRIDE ECHAPPEMENT
EXHAUST FLANGE
V-CLAMP TURBO CHARGER
SORTIE TURBO
TURBO CHARGER

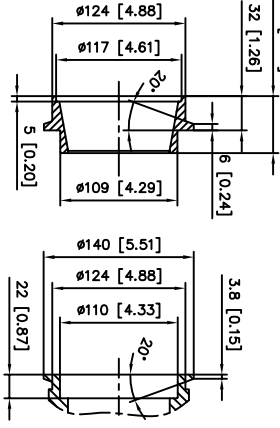

OPTION : SORTIE ECHAPPEMENT DN125
COMPENSATEUR AVEC BRIDES
OPTIONAL : EXHAUST OUTLET DN125
FLEXIBLE WITH FLANGES

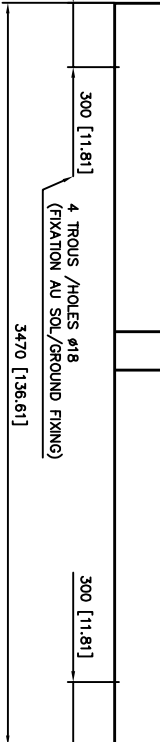
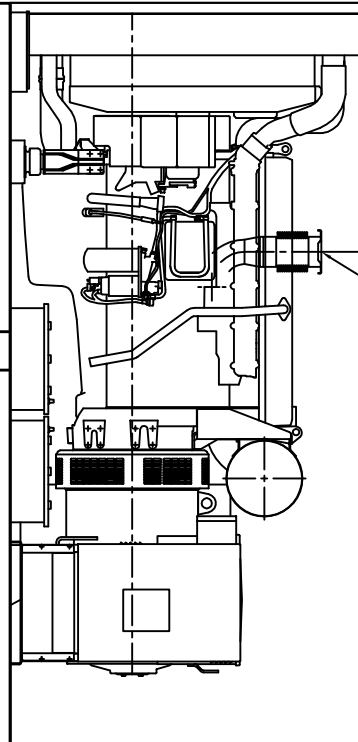

REPARISSEUR AUTOMATIQUE
RESERVOIR
FUEL TANK AUTO FILLING

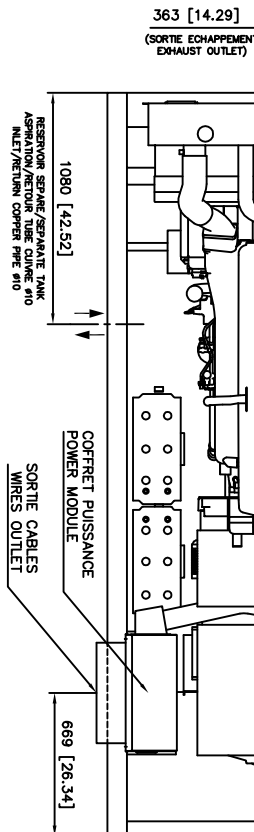
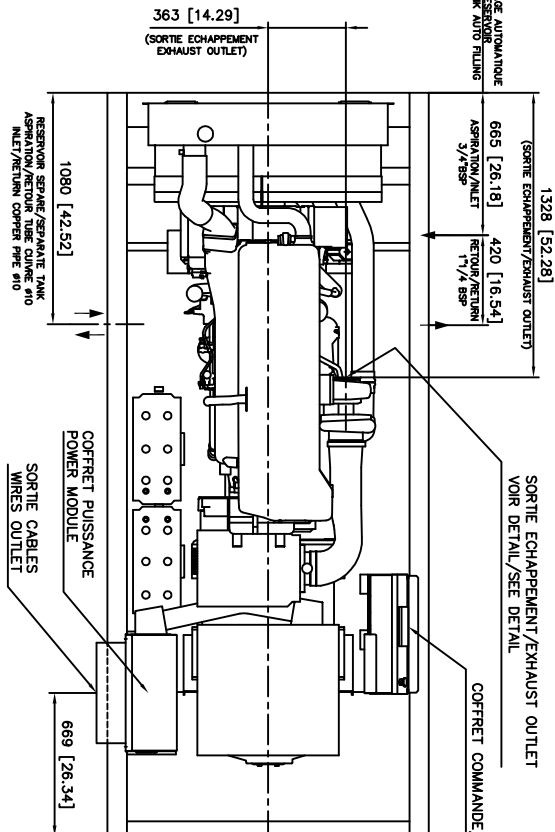

TRANSPORT / MAINTENANCE / TRANSPORT / HANDLING

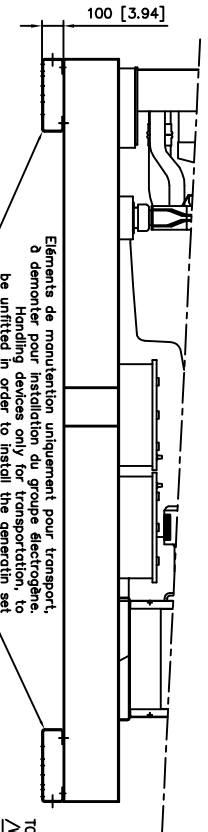

Elements de manutention uniquement pour transport,
à monter pour installation du groupe électrogène.
Handling devices only for transportation, to
be unfitted in order to install the generator set

363 [14.29]
(SORTIE OPTION ECHAPPEMENT
EXHAUST OPTIONAL OUTLET)

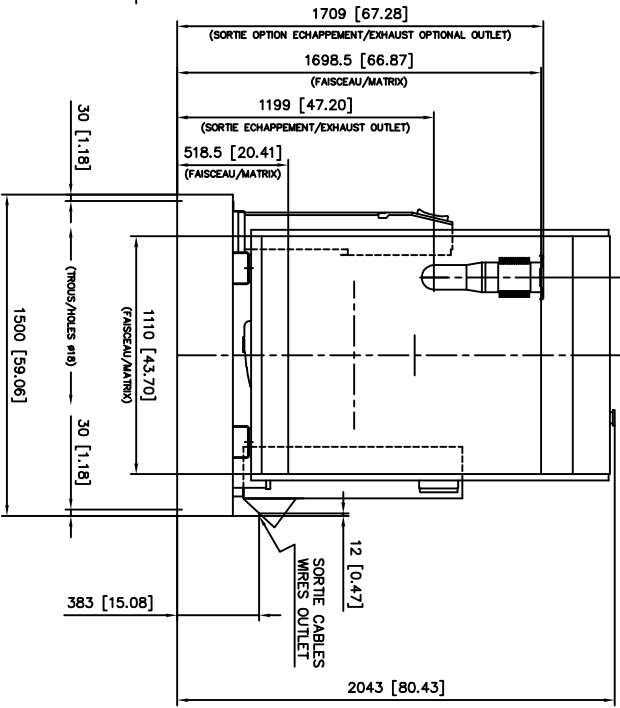
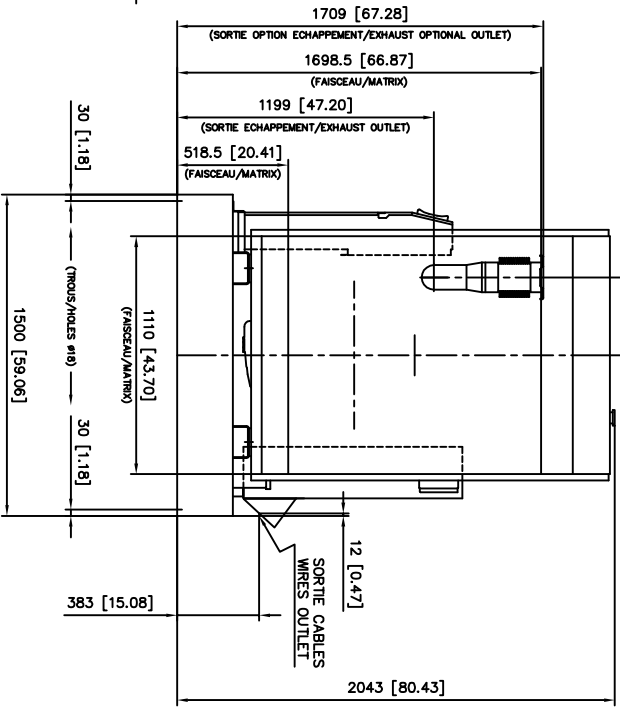

MOTEUR / ENGINE ALTERNATEUR / GENERATOR	MASSE / WEIGHT (Kg / lbs)			
	Avec réservoir / With fuel tank	Sans réservoir / Without fuel tank	A vide / Dry	O.D.M. / Wet
TAD1640GE	3490 / 7694	4030 / 8885	3320 / 7319	3420 / 7540
TAD1640GE	A102450T	3620 / 7981	4160 / 9171	3450 / 7606
TAD1641GE	A102450T	3620 / 7981	4160 / 9171	3450 / 7606
TAD1641GE	A102880T	3760 / 8289	4300 / 9480	3590 / 7915

COFFRET PUISSANCE/POWER MODULE

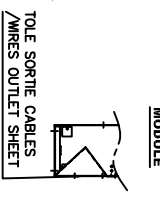

TOLE SORTIE CABLES
WIRES OUTLET SHEET

Ce plan vous est remis à titre indicatif et peut être révisé sans préavis
This drawing is for informational purposes only and may be changed without notice

REVISIONS	NO	DESCRIPTION DE LA MODIFICATION	DATE	DESIGNATION
1	1	REVISIONS	NO	DESCRIPTION DE LA MODIFICATION
2	2	REVISIONS	NO	DESCRIPTION DE LA MODIFICATION
3	3	REVISIONS	NO	DESCRIPTION DE LA MODIFICATION
4	4	REVISIONS	NO	DESCRIPTION DE LA MODIFICATION
5	5	REVISIONS	NO	DESCRIPTION DE LA MODIFICATION
6	6	REVISIONS	NO	DESCRIPTION DE LA MODIFICATION
7	7	REVISIONS	NO	DESCRIPTION DE LA MODIFICATION
8	8	REVISIONS	NO	DESCRIPTION DE LA MODIFICATION
9	9	REVISIONS	NO	DESCRIPTION DE LA MODIFICATION
10	10	REVISIONS	NO	DESCRIPTION DE LA MODIFICATION
11	11	REVISIONS	NO	DESCRIPTION DE LA MODIFICATION
12	12	REVISIONS	NO	DESCRIPTION DE LA MODIFICATION
13	13	REVISIONS	NO	DESCRIPTION DE LA MODIFICATION
14	14	REVISIONS	NO	DESCRIPTION DE LA MODIFICATION
15	15	REVISIONS	NO	DESCRIPTION DE LA MODIFICATION

SDMO 3-00-01-3562-01-B